

1070 Series

0.50 mm SMT Board to Board High Speed

General specifications

Insulator material	LCP, UL94V-0
Contact material	Copper alloy
Current rating	Contact: 1 A, Ground plane: 7.8 A
Voltage rating	125 VAC
Operating temperature	-55 °C to +125 °C
Durability	100 cycles
Soldering	JEDEC lead free reflow soldering process

Mating parts series



Mechanical dimensions

Unit: mm

1070M60

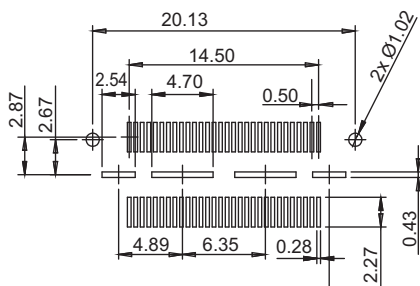
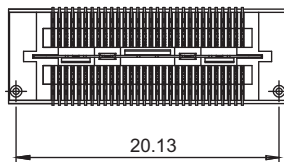
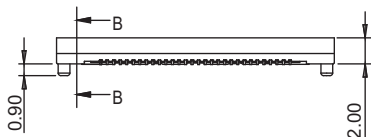
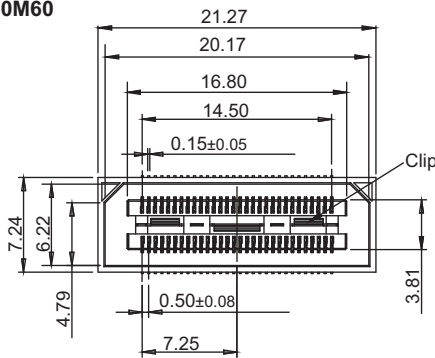

Tolerances		
Linear	X	± 0.30
	X	± 0.20
	XX	± 0.12

Recommended P.C.B. layout tolerances: ±0.03

1070F60

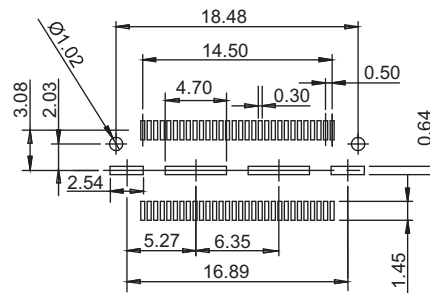
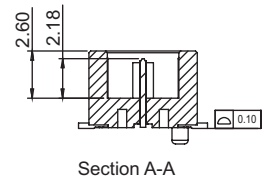
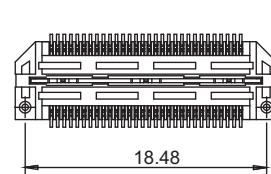
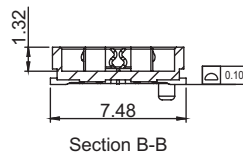
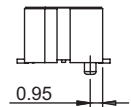
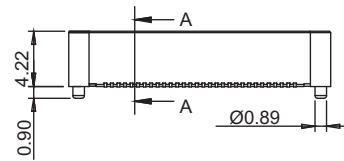
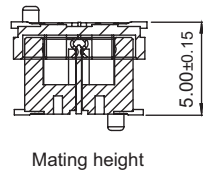
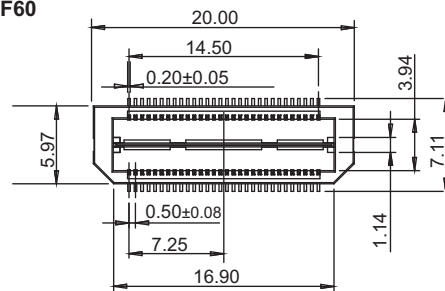

Recommended P.C.B. layout tolerances: ±0.03

Part numbering guide

1070 F

60

D

R

Series
F = Female
M = Male

No. of contacts
60

Contact plating
D = 6 μ" gold

Packing
R = Reel

* standard

