

General specifications

Insulator material	LCP, UL94V-0
Contact material	Copper alloy
Current rating	Contact: 1 A, Ground plane: 7.8 A
Voltage rating	125 VAC
Operating temperature	-55 °C to +125 °C
Durability	100 cycles
Soldering	JEDEC lead free reflow soldering process

Mating parts series



Mechanical dimensions

Unit: mm

1071-M

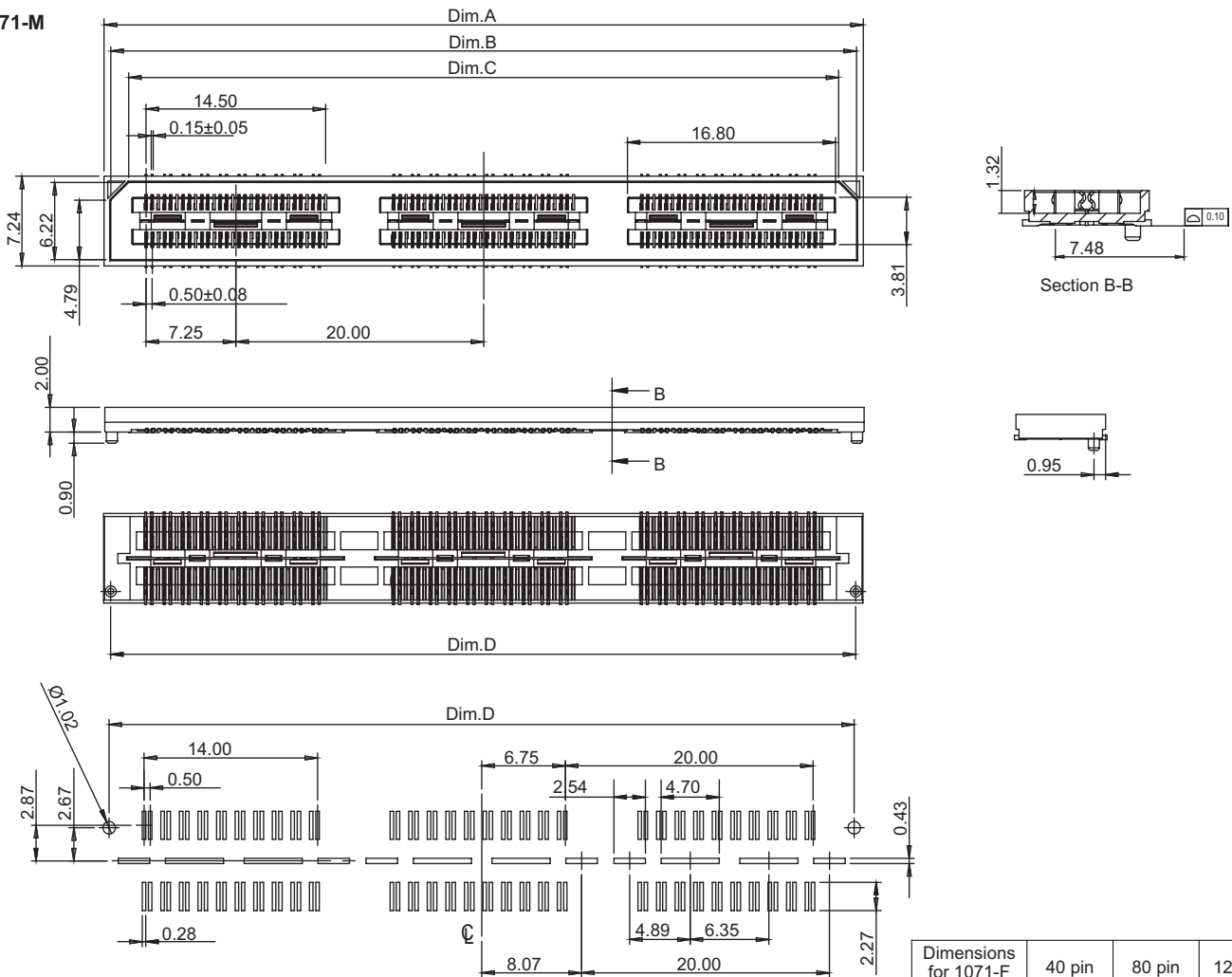

Recommended P.C.B. layout tolerances: ±0.03

Dimensions for 1071-F	40 pin	80 pin	120 pin
Dim.A	21.27	41.27	61.27
Dim.B	20.17	40.17	60.17
Dim.C	17.17	37.17	57.17
Dim.D	20.13	40.13	60.13

Tolerances		
Linear	X	± 0.30
	X	± 0.20
	.XX	± 0.12

Part numbering guide

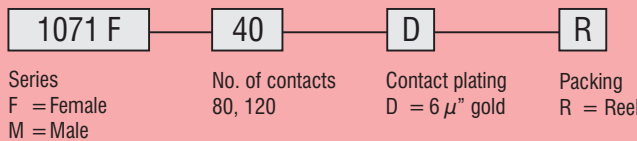

* standard



Mechanical dimensions

Unit: mm

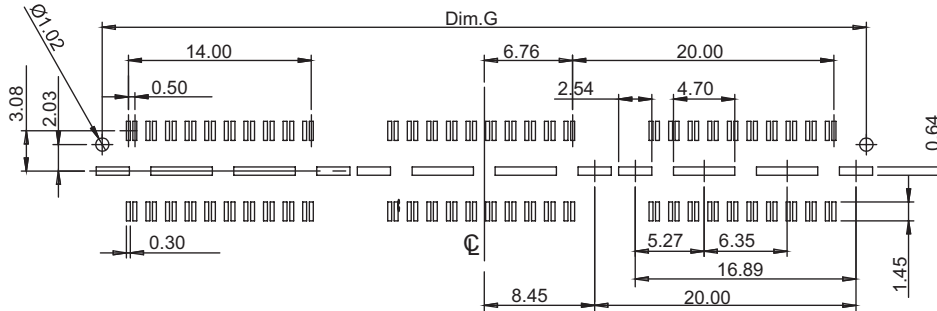
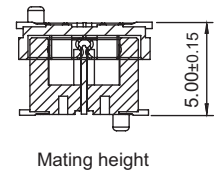
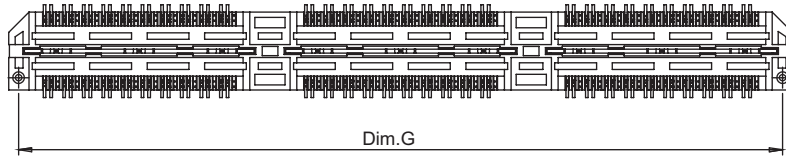
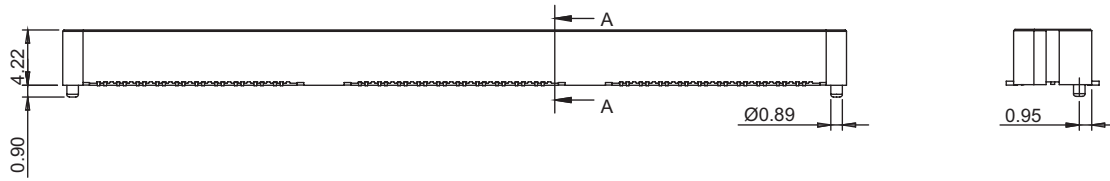
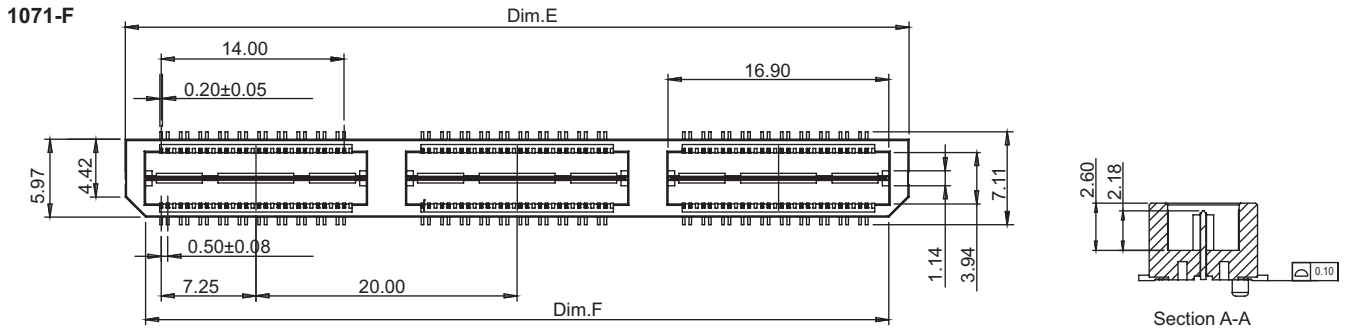

Recommended P.C.B. layout tolerances: ±0.03

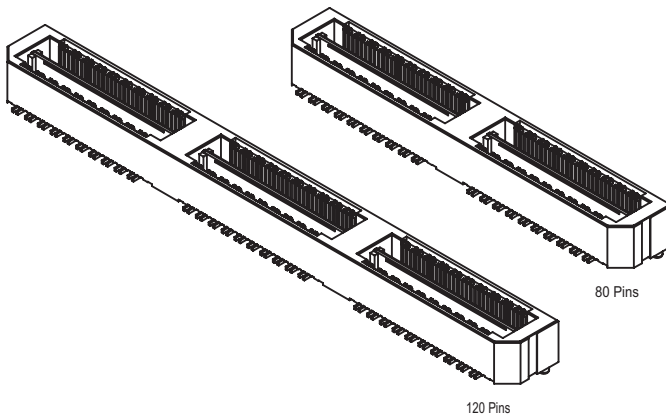

Tolerances	
Linear	X ± 0.30
	.X ± 0.20
	.XX ± 0.12

Dimensions for 1071-M	40 pin	80 pin	120 pin
Dim.E	20.00	40.00	60.00
Dim.F	16.90	36.90	56.90
Dim.G	18.48	38.48	58.48

