

Series 43061 Mini DIN - 3x RCA Jack Combination

Material

Housing: PBT + Glass fiber
 Mini DIN Term.: Phosphor bronze, tin plated
 RCA Term.: Brass, tin plated
 Shield: Brass, nickel plated

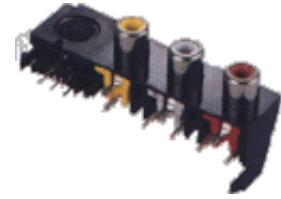

Electrical

Rating: 0.2 Amp @ 50 VDC
 Contact resistance: 30 mΩ max.
 Insulator resistance: 100 MΩ min.
 Dielectrical withstanding: 250 VAC/minute
 Operating temperature: -25°C ~ +70°C
 Durability: 100 cycles

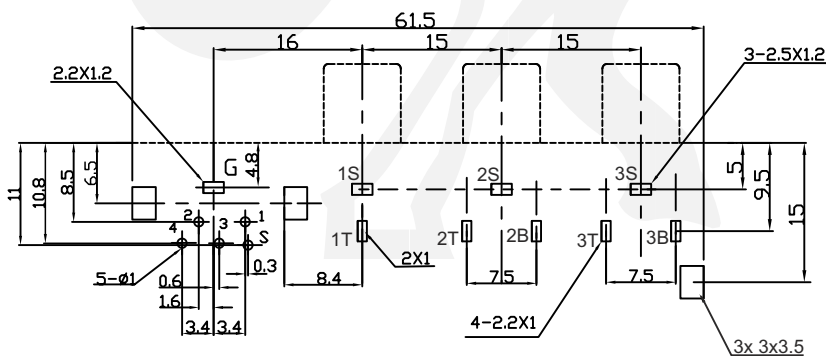
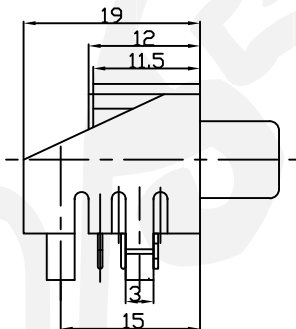
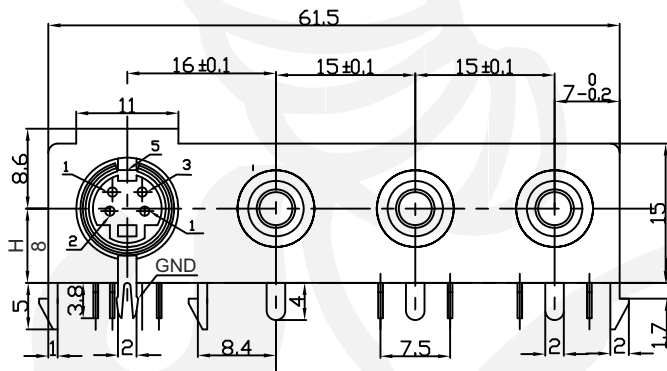
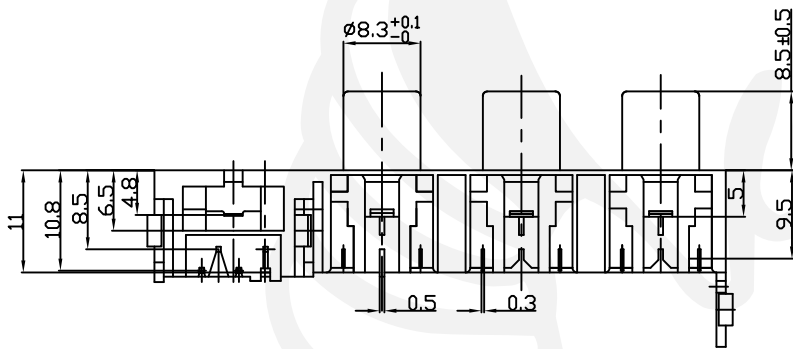

Recommended P.C.B. Layout

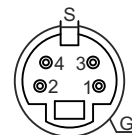
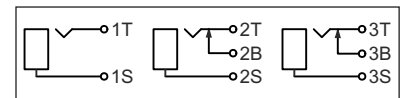

Tolerances	
Linear	<6 ± 0.1
	6-20 ± 0.2
	>20 ± 0.3



All dim. in mm

43061 Z — **01**

Series
43061Z

Color code
 01 = black 05 = green
 02 = red 06 = orange
 03 = white 07 = yellow
 04 = blue

Packing
Tray