

49601 Series SMB Jack Right Angle

General specifications

Insulator material	Teflon
Contact material	Brass, plating: gold
Body material	Brass, plating: gold
Impedance	50 Ω
Frequency range	0 to 4 GHz
Contact resistance	Center: 6 mΩ max. / outer: 2.5 mΩ max.
Insulator resistance	1000 MΩ min.
VSWR	1.5 max.
Operation temperature	-65 C to +165 C
Durability	500 cycles

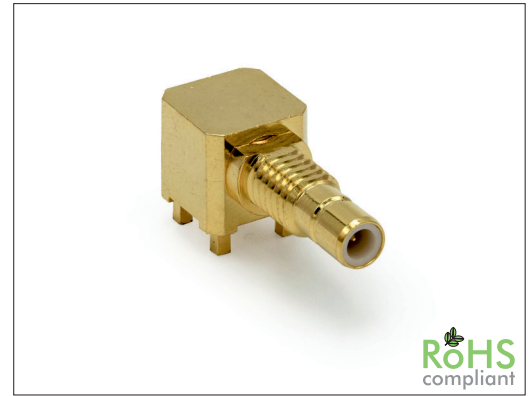

RoHS
compliant

Mechanical dimensions

Unit: mm

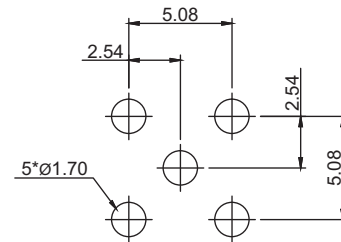
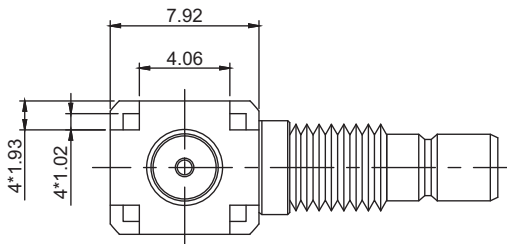
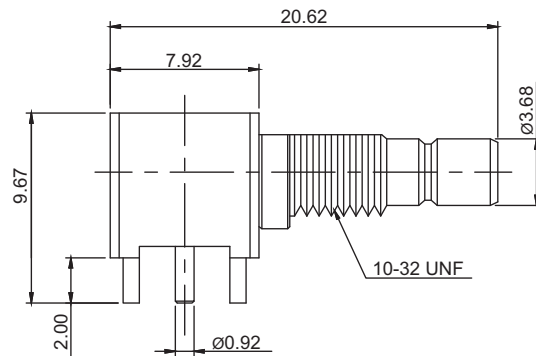

Recommended P.C.B. layout

Optional available:

Nut

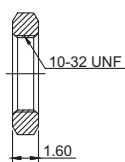
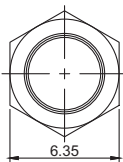

Lock washer

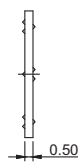
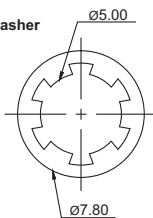

Washer

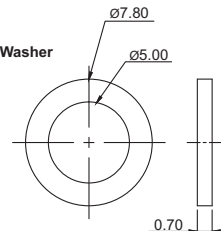

Tolerances		
Linear	<6	± 0.2
	6 to 30	± 0.4
	>30	± 0.6

Part numbering guide

49601 R

50

Series

Impedance
50 = 50 Ω

* standard

