

5922 Series

AC Inlet Socket Solder Type

General specifications

Insulator material	Thermoplastic w/ glass fiber, UL94V-2 to UL94V-0
Current rating	2.5 A
Voltage rating	250 VAC
Insulator resistance	100 MΩ min.
Dielectrical withstanding	2000 VAC for 1 min
Operation temperature	-25 °C to +85 °C
Soldering	Lead free wave soldering process

Safety approvals available, certificates on request

Mating parts series



RoHS
compliant

Mechanical dimensions

Unit: mm

5922A0

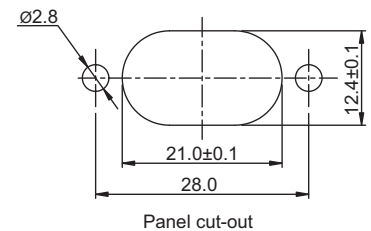
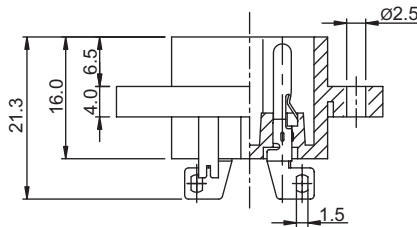
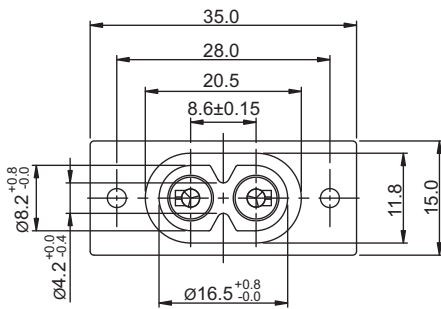

5922A2

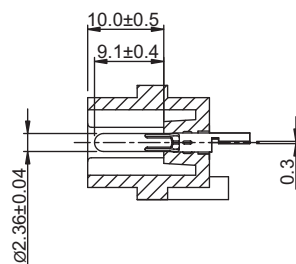
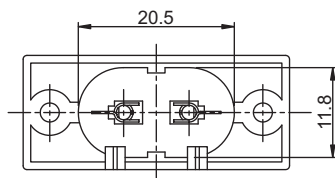
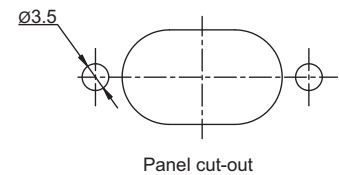
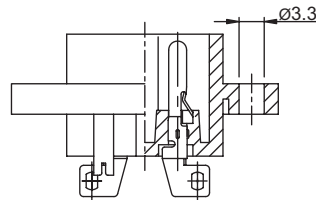
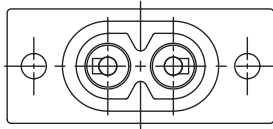

Tolerances	
Linear	XX.XX ± 0.20
	X.XX ± 0.10

Part numbering guide

5922 A	0	V0
Series	Mounting hole 0 = 2.5 mm 2 = 3.3 mm	Material V0 = UL94V-0 V1 = UL94V-1 V2 = UL94V-2

* standard

