

Series 43900 9x RCA Jack / Cinch

Material

Base, insulator: ABS
 Color washer: PBT + 15% glass fiber
 Contact break / needle: H65 Brass / QSn 6.5-0.1

Electrical

Rating: 0.2 Amp @ 50 VDC
 Contact resistance: 30 mΩ max.
 Insulator resistance: 100 MΩ min.
 Dielectrical withstanding: 500 VAC/minute
 Operating temperature: -40°C ~ +70°C
 Durability: 500 cycles

43900A



43900A

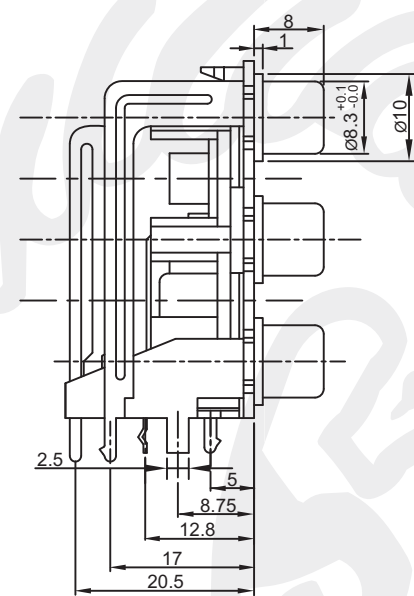
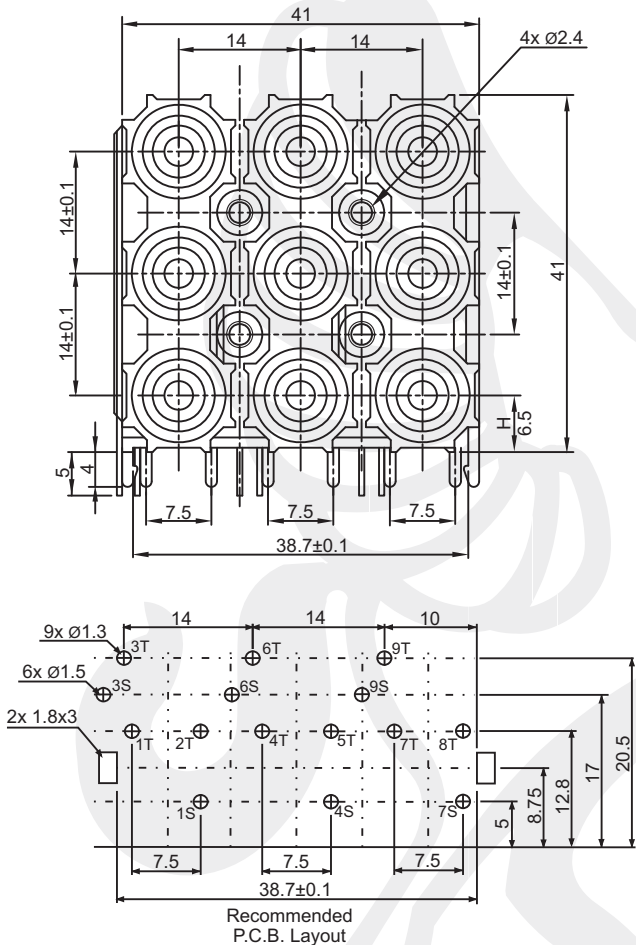

Color layout

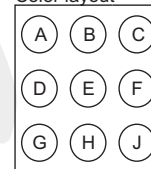

Code	A D G	B E H	C F J
01	t.b.d. by customer		

Tolerances	
Linear	<6 ± 0.1 6-20 ± 0.2 >20 ± 0.3



All dim. in mm

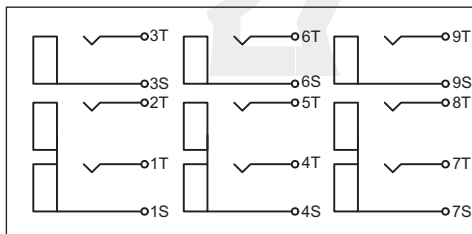

43900 A — **01**

Series
43900A
43900B

Color code
see table

Packing
Box

Series 43900 9x RCA Jack / Cinch

43900B

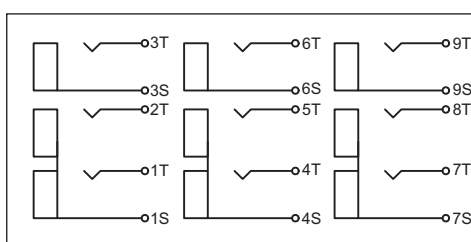
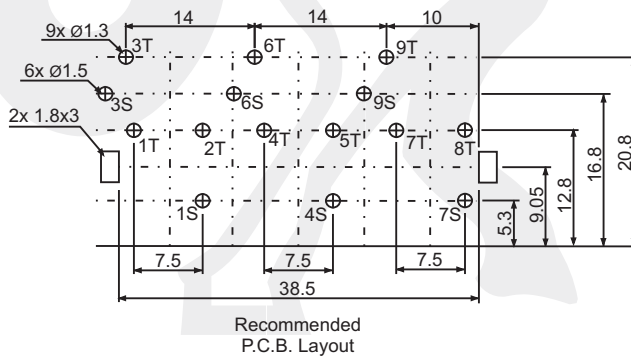
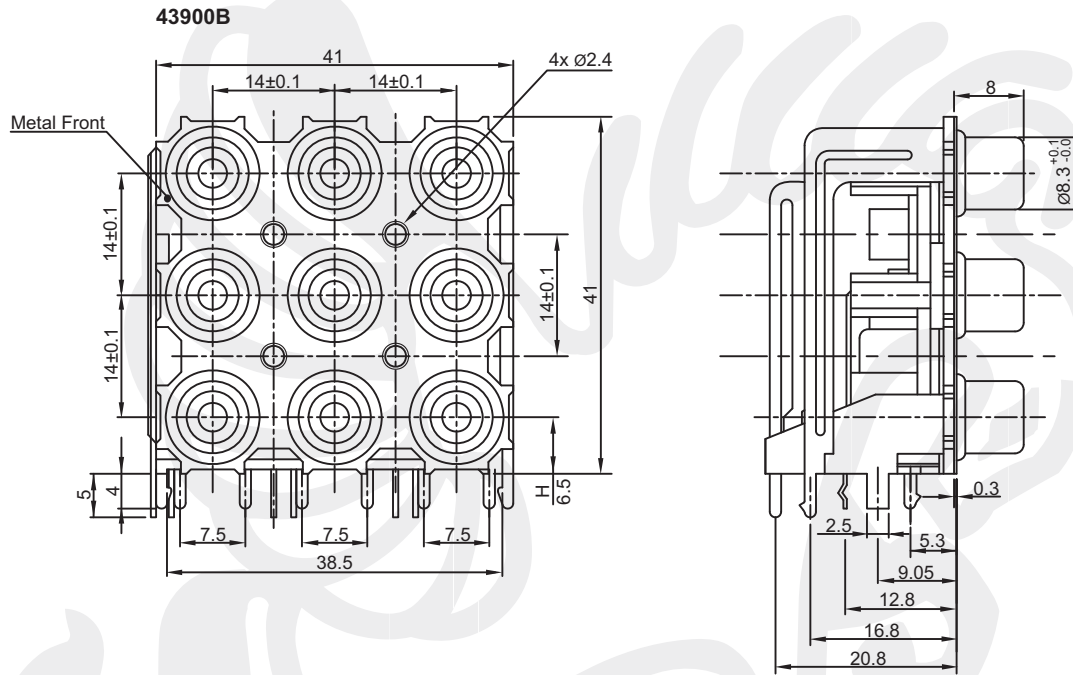

Tolerances	
Linear	<6 ± 0.1
	6~20 ± 0.2
	>20 ± 0.3



All dim. in mm