

5905 Series

AC Inlet Socket for P.C.B. Snap In

General specifications

Insulator material	Glass-filled thermoplastic, color: black
Current rating	2.5 A
Voltage rating	250 VAC
Insulator resistance	100 MΩ min. @ 500 VDC
Dielectrical withstanding	2000 VAC for 1 min
Soldering	Lead free wave soldering process
Safety approvals available, certificates on request	
Mating parts series	

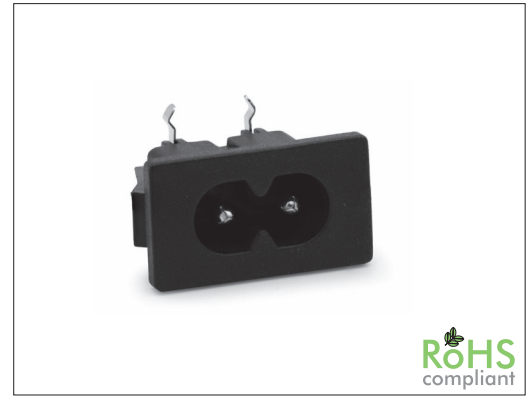

Mechanical dimensions

Unit: mm

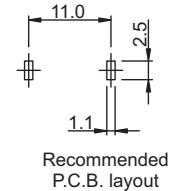
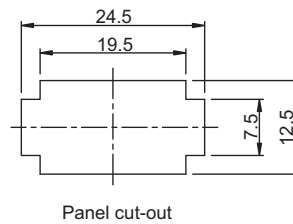
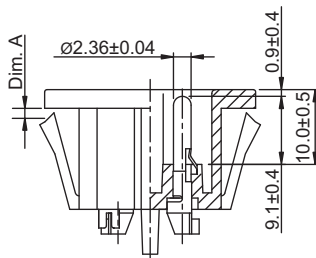
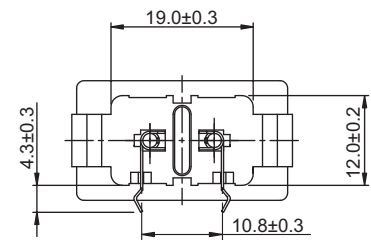
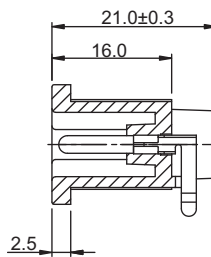
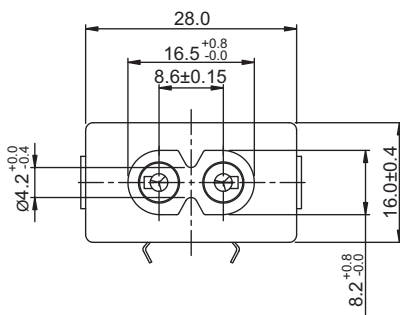

Part numbering guide

5905 A

Series

18

Panel thickness Dim.A
18 = 1.8 mm

V0

UL-Material
V0 = UL94V-0
V1 = UL94V-1
V2 = UL94V-2

* standard

