

# 61350 Series RJ10 4P Side Entry

## General specifications

Insulator material	PBT w/ glass fiber, UL94V-0, color: black
Contact material	Phosphor bronze
Current rating	1 A
Voltage rating	150 VAC
Contact resistance	50 mΩ max.
Insulator resistance	200 MΩ min.
Dielectrical withstanding	1000 VAC for 1 min
Operating temperature	-40 °C to +85 °C
Soldering	Lead free wave soldering process
Durability	750 cycles

## Mating parts series



## Mechanical dimensions

Unit: mm

w/o panel stop

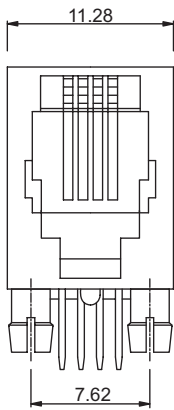

w/ panel stop

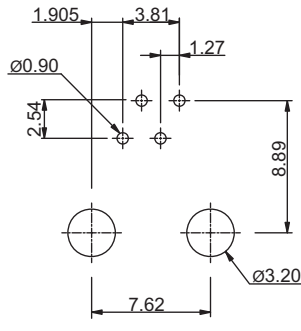
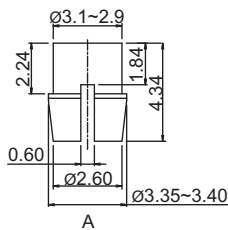
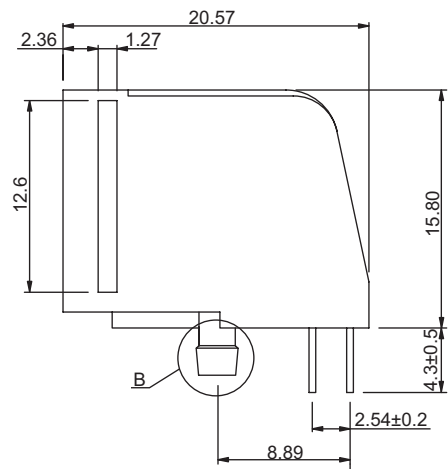
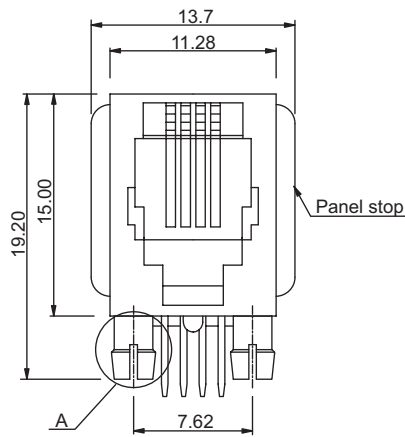

Recommended P.C.B. layout

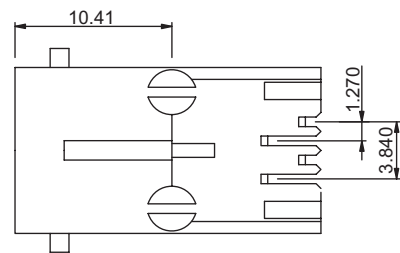
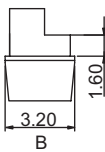

### Tolerances

Linear	X	± 0.25
	.XX	± 0.13
	.XXX	± 0.05

## Part numbering guide

61350 — C — 0

Series

Contact plating

Panel stop

C = 3 μ" gold K = 50 μ" gold

0 = w/o panel stop

D = 6 μ" gold

1 = w/ panel stop

F = 15 μ" gold

J = 30 μ" gold

\* standard

