

64338 Series RJ45 8P Side Entry

General specifications	
Insulator material	High temperature plastic , UL94V-0, color: black
Contact material	Phosphor bronze
Current rating	1 A
Voltage rating	125 VAC
Contact resistance	50 mΩ max.
Insulator resistance	200 MΩ min.
Dielectrical withstanding	1000 VAC for 1 min
Operating temperature	-40 °C to +85 °C
Soldering	Lead free wave soldering process
Durability	750 cycles
Mating parts series	

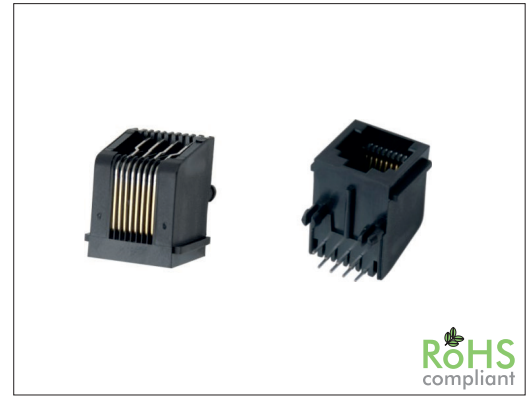

Mechanical dimensions

Unit: mm

w/o panel stop

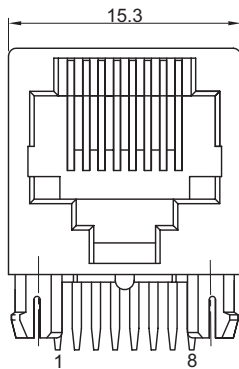

w/ panel stop

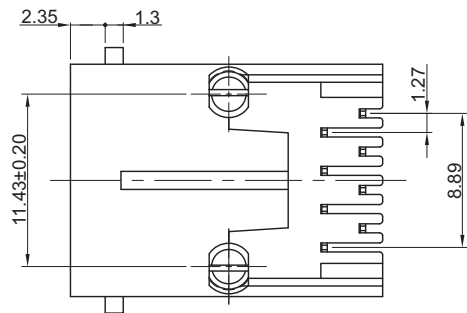
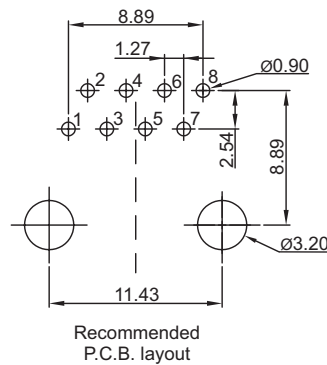
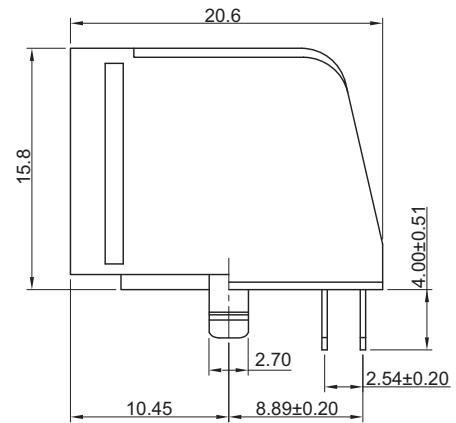
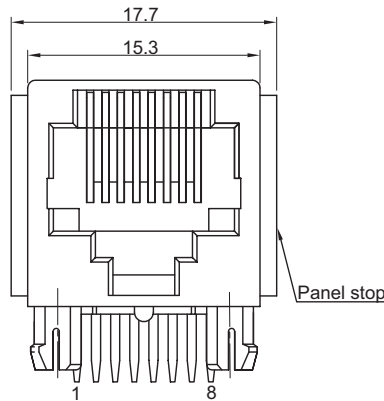

Tolerances		
Linear	X	± 0.20
	.XX	± 0.15
	.XXX	± 0.10

Part numbering guide

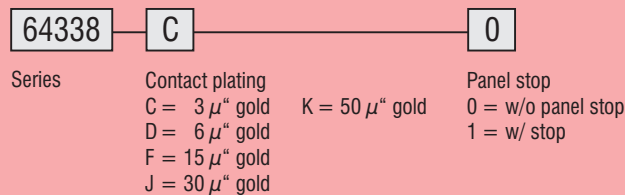

* standard

