

Materials

Carrier	PS tape, thickness: 0.50 mm
Cover tape	Transparent PE tape, thickness: 0.045 to 0.120 mm
Reel	Plastic wheel

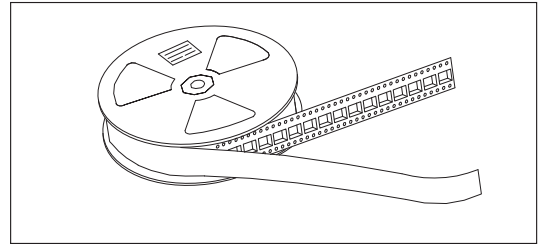

Reel and tape dimensions

Unit: mm

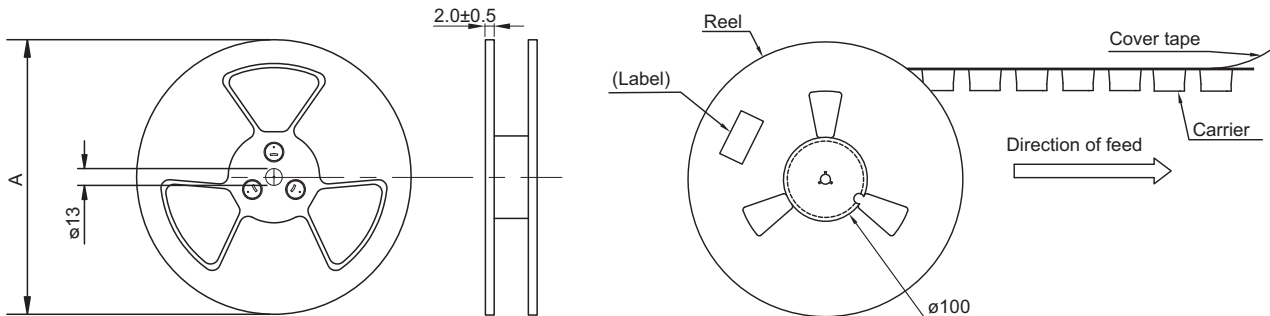
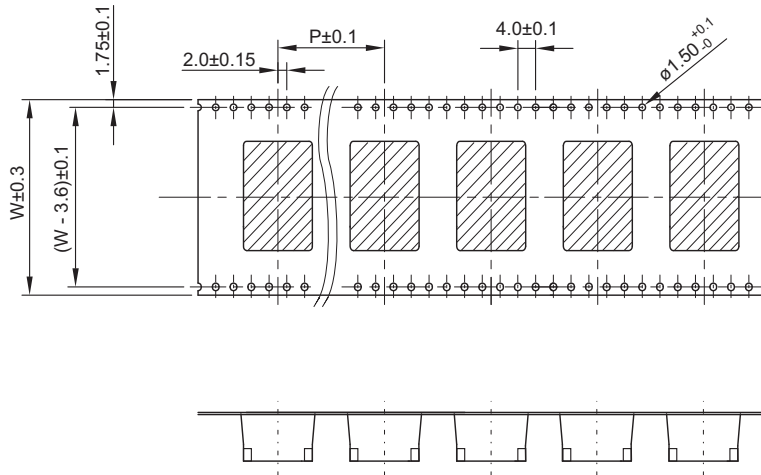

Reel and tape dimensions			
A	W	P	Qty.
380	32	20	350

