

# 65330 Series RJ45 10P Side Entry

## General specifications

Insulator material	PBT w/ glass fiber, UL94V-0, color: black
Contact material	Phosphor bronze
Current rating	1.0 A
Voltage rating	150 VAC
Contact resistance	50 mΩ max.
Insulator resistance	200 MΩ min.
Dielectrical withstanding	1000 VAC for 1 min
Operating temperature	-40 °C to +85 °C
Soldering	Lead free wave soldering process
Durability	750 cycles

## Mating parts series



## Mechanical dimensions

Unit: mm

w/o panel stop or key

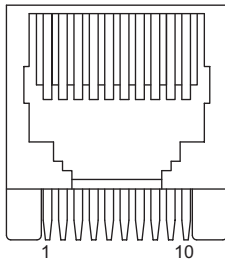

w/ key

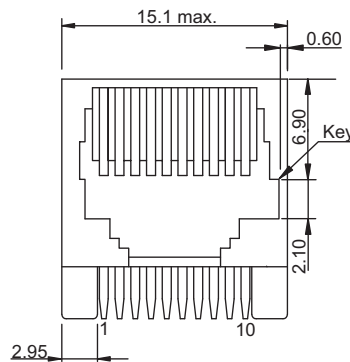

w/ panel stop

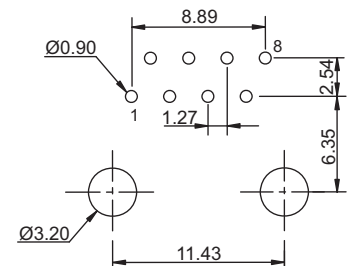
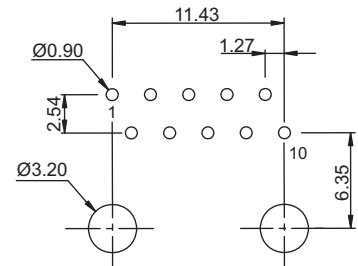
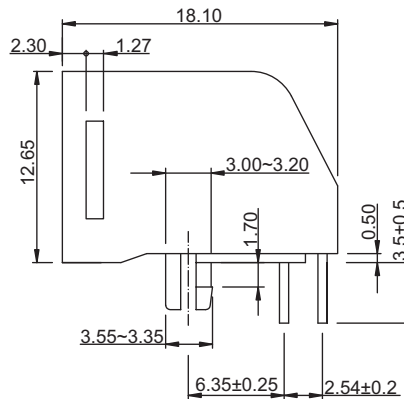
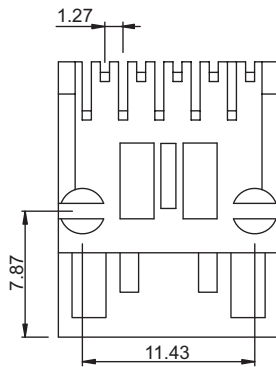
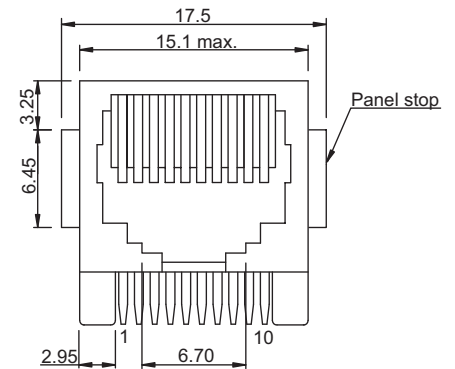

Recommended P.C.B. layout

### Tolerances

Linear	X	± 0.25
	.XX	± 0.13
	.XXX	± 0.05

## Part numbering guide

65330	C	8	0	0
Series	Contact plating C = 3 μ <sup>s</sup> gold D = 6 μ <sup>s</sup> gold F = 15 μ <sup>s</sup> gold J = 30 μ <sup>s</sup> gold	No. of contacts 8 = 8 1 = 10	Panel stop 0 = w/o panel stop 1 = w/ panel stop	Key 0 = w/o key 1 = w/ key

\* standard

