

Series 43800 8x RCA Jack / Cinch

Material

Base, insulator: ABS
 Color washer: PBT + 15% glass fiber
 Contact break / needle: H65 Brass / QSn 6.5-0.1

Electrical

Rating: 0.2 Amp @ 50 VDC
 Contact resistance: 30 mΩ max.
 Insulator resistance: 100 MΩ min.
 Dielectrical withstanding: 500 VAC/minute
 Operating temperature: -40°C ~ +70°C
 Durability: 500 cycles

43800A

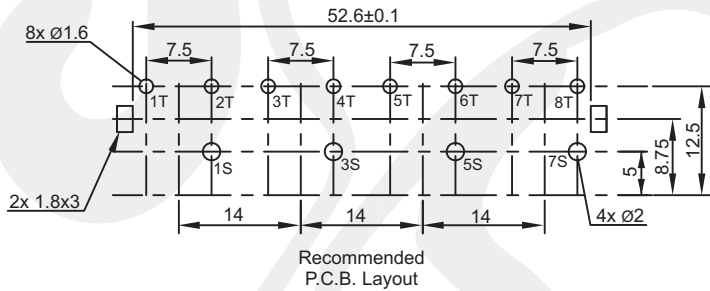
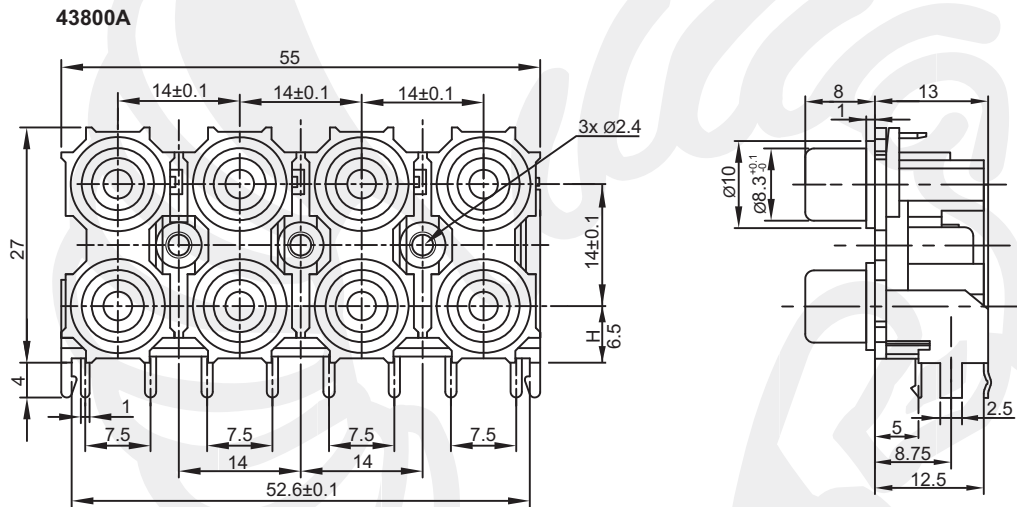

Color layout

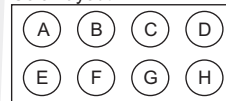

Code	A E	B F	C G	D H
01	white red	green red	blue white	red black
02	white red	white red	green black	blue orange
03	white red	white red	white red	white red
04	t.b.d. by customer			

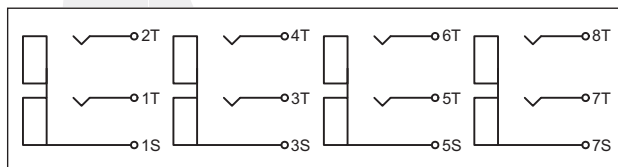

Tolerances	
Linear	<6 ± 0.1 6-20 ± 0.2 >20 ± 0.3



All dim. in mm

43800 A — **01**

Series 43800A
 43800B
 43800C

Color code see table

Packing Box

Series 43800 8x RCA Jack / Cinch

43800B

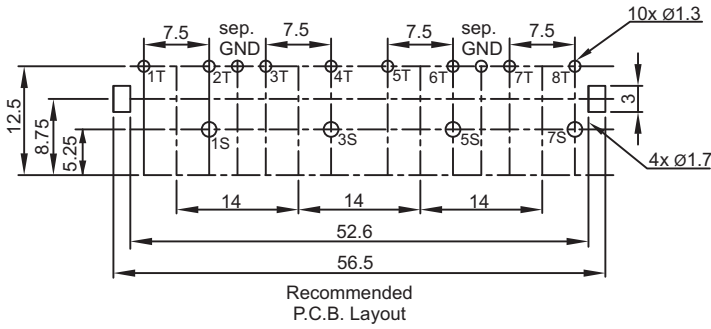

43800B



43800C

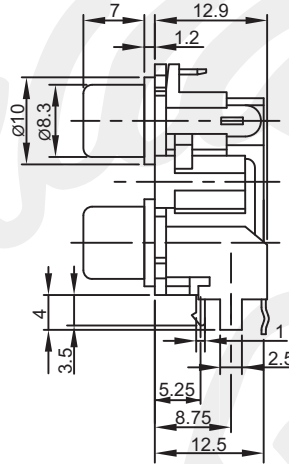
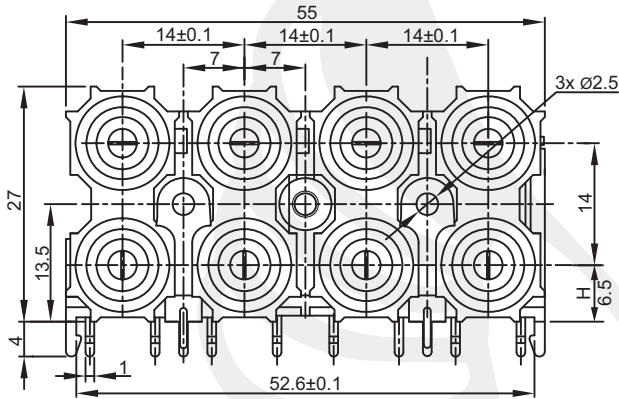
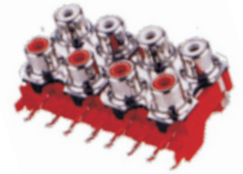

43800C

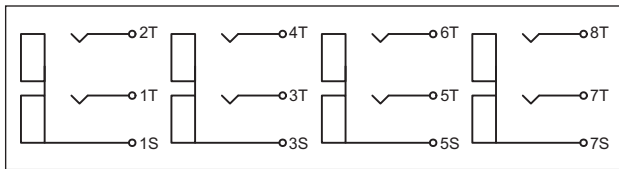
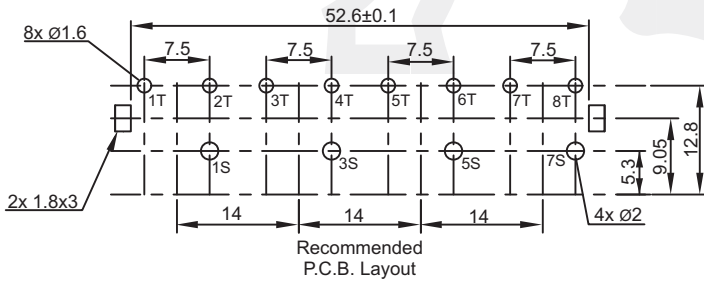
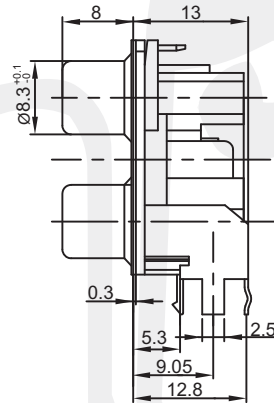
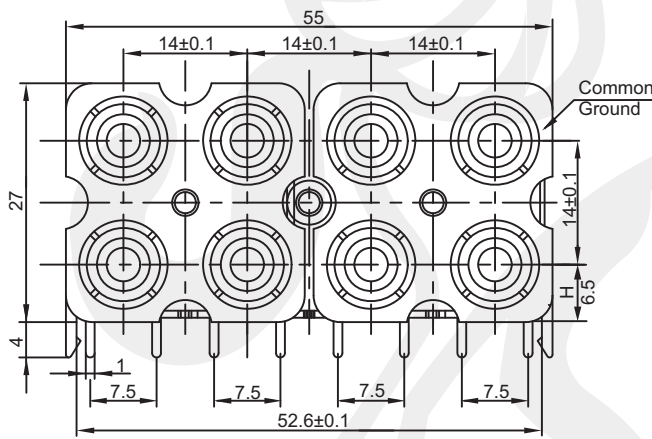

Tolerances	
Linear	<6 ± 0.1
	6-20 ± 0.2
	>20 ± 0.3



All dim. in mm